

IOT BASED COVID-19 SAFETY SYSTEM

Abhinav Gulati¹, Pratik Chaudhary², Nikhil Yadav³, Tapan Rajput⁴, Tania Gupta⁵, Shailendra Bisariya⁶

¹⁻⁴ *Department of Electronics and Communication, ABES Engineering College, Ghaziabad, Uttar Pradesh, India.*

^{5,6} *Assistant Professor, Department of Electronics and Communication, ABES Engineering College, Ghaziabad, Uttar Pradesh, India.*

Abstract. When an infected individual coughs or sneezes, the Corona virus (COVID 19) is spread largely by saliva droplets or through the nose. Covid-19 is rapidly growing and poses a threat to humans. Medicine and vaccinations are in short supply. The methodology described has the potential to lower the number of people infected with the virus. Taking everyone's temperature at the same time and determining whether or not they are wearing a mask is tough. Security guards at shopping malls, schools, and other businesses are increasingly scrutinising public temperature readings before allowing them to enter their facilities. To keep a safe distance from COVID patients and wash your hands frequently to kill the corona virus. Automatic detection of the aforementioned features will assist both the government and the general people. The report provided a remedy to the problem. The brochure promotes an automatic hand sanitizer with a temperature-detecting technology that allows users to sanitise their hands at any moment without touching the sanitizer. The temperature of the individual is displayed once this temperature sensor is touched. The door will automatically open if the body temperature is normal; otherwise, it will remain closed. Keep a safe distance from COVID patients and wash your hands frequently to kill the corona virus.

Keywords: COVID19, MLX90614, HC-SR04, microcontroller, Thermal Sensor.

INTRODUCTION

The coronavirus illness, commonly called as COVID-19, started from Wuhan, China, & has since expanded to other countries, including India, which has a total of around 134 billion people. India would face challenges in preventing the spread of the coronavirus due to its massive population. Work, social interactions, sports, and off-screen and on-screen recreation have all been touched by the COVID-19 epidemic. People with a high body temperature should not be allowed into public spaces because they risk becoming infected and spreading the virus; a mask is required. Temperature and mask checks are also required at

the gates to any city, business, mall, or hospital. As a result, a smart entrance device was developed that measures human body temperature, detects distance, and automatically sanitises the door opening mechanism. A cutting-edge notion is used in this system technique: a mix of temperature detection and sanitization.

Because pressing the pump handle is inconvenient, many people walk right past without disinfecting their hands. Furthermore, because everyone uses the pump handle differently, predicting how much you'll need and managing refills and replacements is impossible. As a result, people are using fewer hand sanitizers, which does little to stop the virus from spreading.

LITERATURE SURVEY

The work "Temperature Discovery and Automatic Sanitization and Disinfection for COVID 19" was published by [1]. They installed an LM 35 temperature detector in this system, which tells us whether the temperature is normal or abnormal. Using the Arduino UNO, we created and implemented an automated temperature detector and sanitization system. The experimental data's delicacy was confirmed across a wide range of temperature settings. [2] et al. A Snap (16F72) and a PIR detector were used to construct the system. This study demonstrated how to make an automatic door using only infrared detectors. As a result, the cost of constructing an automatic door was decreased. According to [3], "Automatic Opening and Closing of Door" is a concept that attempts to create a fully automated security access system for both home and artificial use. [4] says "Automatic Garage Door Opener." This design aims to create an electro-mechanical corridor system that works as a whole, can be installed in tandem with sliding or rolling doors in garages or shops around the world, and can be operated with minimal effort, all for the purpose of increasing security by controlling entry and exit with an electromagnetic card or biometric detector. The major goal of the "Motion Based Automatic

Garage Door Opener," according to [5], was to create an automatic door opening system that utilised infrared detectors to eliminate the need for homemade labour. Design of Automatic Hand Sanitizer with Temperature Seeing, according to [6]. As part of the study, a prototype of an automatic hand sanitizer with temperature sensor was created. According to [7], a project that aims to develop an automatic system that disinfects door clouds/ handles and effectively prevents bacteria from spreading through them. In "Review on Automatic Sanitizer Allocating Machine," [8] offers an automatic sanitising method in which the stoner is sanitised without having any touch with the machine. [9] published an article titled "Development of a Mechanical Door System," which focuses on the creation of a low-cost mechanical door assembly. As detailed in [10], et al. The additional monitoring system created in this study can assess water temperature in real time between 30 and 70 degrees Celsius, this falls inside the Korean NPP's temperature range. The study developed a contactless optical fiber temperature detector that measures water temperature accurately. [11] discusses how an Arduino board works and how it is programmed. This also takes into account how it might be used for study and exploration. The Arduino board can be used to quickly construct VLSI test benches, especially detector test benches. Rapid-fire processing and a simple stoner interface are two key benefits. According to a study [12], In acute care settings, using alcohol based sanitizer can help lower rates of infection and provide a new alternative for effective infection control programme. [13] et al, During the COVID-19 outbreak, a WT webbing centre provides safe and rapid treatment while retaining access to the healthcare system, especially in resource-constrained communities. We hope to do this through excellent infection operation and adaptation, using being and unborn technologies be a cornerstone in the construction of a WT system that requires the least amount of patient participation [14] as the title implies the purpose of the concept was to monitor and regulate the temperature in a boy's room. The device can set a target room temperature within a specific range, with less than 1 degree overshoot and steady-state temperature inaccuracy, and track it in real time. The Arduino Uno, which is IoT enabled and features a temperature sensor, is chosen as the design platform (LM35). [15] describes the internet of things (IoT) is a network of interconnected physical devices that may gather and share data and are connected to the internet through electronics, software sensors, and network connectivity. The purpose of the research is to develop a method that can monitor and regulate the device on its own. It's clear from the material that a contactless sanitizer and door opener are necessary. The MLX90614 sensor is used in

conjunction with Arduino to build a contactless temperature estimation and door (gate) access system for the pandemic emergency. As a result, the current screening techniques reduce the risk of infection spread. The MLX90614 sensor measures a person's temperature via infrared radiation. The foundation is simple. This framework can be used in places like airports, train stations, shopping malls, and other public places to help customers by restricting the space in which a sick person can spread infection and reducing the transmission of infection.

COMPONENTS USED

Arduino Uno:

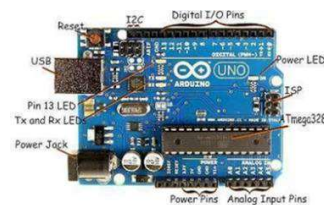

The ATmega328P is used in the Uno microcontroller. A 16 MHz crystalline quartz, a USB connection, a USB connector, an IcsP, and a reboot button are all included on the board. Using pinMode(), digitalWrite(), and digitalRead() functions, each of the 14 digital pins can be used as an input or output. They operate on 5 volts. Each pin has a designed and built 20-50k ohms pull-up resistors (by default disconnected) and is capable of supplying or receiving 20 mA.

Liquid Crystal Display:

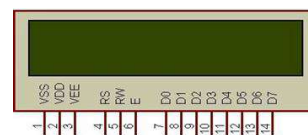

LCD displays combine two layers of polarized materials with a liquid crystal. LCDs are commonly found in digital watches and portable laptop computers. They reached an agreement. When an electric charge is passed across the fluid, the crystal align and light cannot pass through. LCD technology has advanced at a dizzying speed since its inception more over years since used in laptop computers. Technological innovation has resulted in brighter displace, higher resolutions, quicker response, and a better cost-effective production process.

Temperarure Sensor:

Temperature sensors are electrical devices that measure and transform the temperatures of their environment into electronic data to store, track, or report temperature changes. Temperature sensors are available in a variety of sizes and types. Some thermistors (contact temperature sensors) must be in direct contact with the actual thing being measured, whereas others (indirect temperature sensors) detect the temperature of an object passively (non-contact temperature sensors).

IR Sensor:

An ir sensor is a light-producing electrical device that can identify different objects. An infrared sensor can both detect motion and measure the heat of an item. In the infrared spectrum, everything emits some form of heat radiation. These radiations are invisible to the naked eye, but an infrared sensor can detect them.

Zero PCB:

Zero PCB a thin, strong copper plate having 2.54mm spaced holes pre-drilled at regular intervals across a grid (0.1 inch). Every slot is covered by a round or

square copper pad that enables parts to be connected across the pads without short-circuiting the adjoining pads or other leads. Solder or join the leads of one component to the leads of another component with appropriate conducting wire.

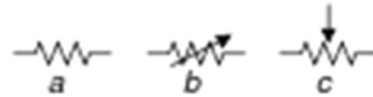
Resistor:

Resistors are employed in electronic circuits for a variety of purposes, including controlling current flow, adjusting signal levels, dividing voltages, biasing active devices, and terminating transmission lines. High-power resistors are often employed in motor controller, power transmission systems, including generator test loads because they can dissipate several watts of electricity as heat.

Capacitor:

The capacitor, like a miniature rechargeable battery, may store energy as a form of voltage, results as voltages (Static Voltage) across its plates.

Capacitors come in a range of sizes and colors, ranging from tiny capacitor beads in use in resonant circuit to gigantic voltage control capacitor, however all all store charge.

DC pump:

A 9V DC pump was used to remove the sanitizer. A 2.5-9V power supply can be used to power this little submersible pump motor. It could take up to 120 hours with a very moderate current usage of 220ma. To switch on the DC pump, we used a relay module..

SOFTWARE USED

Arduino IDE:



A text editor for writing the program, and a text box, a text console, and a toolbar with basic task buttons, are all included in the Uno Integrated Development Environment, and a menu system (IDE). It establishes a connection to an Arduino platform and sends programmes to it. The Arduino software language is used to create computer programmes called sketches (IDE). These illustrations were created with an editor and saved as .ino files. You may cut/paste and also look over and replace text in the editor. While storing and exporting, the message section displays concerns and provides feedback. The Arduino IDE outputs messages to the console, which includes comprehensive notifications and other data. The taskbar buttons can be used to test & upload algorithms, as well as open the serial monitor and create, open, and save sketches.

C Programming:

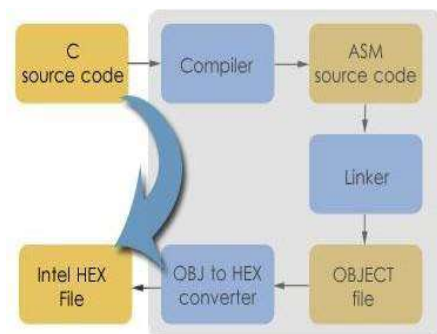

C is a programming language for computers that may be used to do a wide range of activities. It was invented in the 1970s and is still quite popular. C's features are intended to accurately reflect the capabilities of the CPUs that are being targeted. It's still used in operating systems, device drivers, and protocol stacks, albeit less so in application software, and it's found its way into everything from supercomputers to microcontrollers and embedded

systems. With a static type system, C is a procedural imperative language that allows for systematic coding, global variables scoping, and recursion. It was designed to be compiled in order to provide low storage accessibility and language constructs that transfer easily to machine instructions with minimum runtime assistance. Despite its low-level capabilities, the language was designed to promote cross-platform programming.

With just a few modifications to the source code, a standards-compliant C programme created with adaptability in consideration can be built for a wide range of computer platforms and operating systems.

Since 2000, the TIOBE index, which measures the popularity of programming languages, has continuously placed C among the top two languages.

BLOCK DIAGRAM

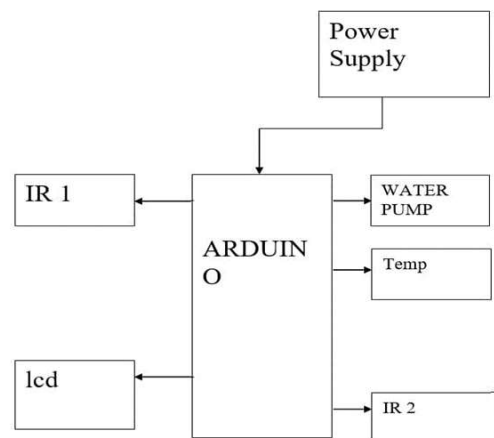

METHODOLOGY

The idea for this project was conceived by witnessing the rapid spread of Corona virus diseases also known as Covid 19 across the world which emerged in December 2019. The disease spread has infected massive amount of people and caused tremendous loss of population in the year 2020, stepping to 2021 as well. The major symptoms of this disease are breathlessness and high temperature. It infects the respiratory organs like lungs thereby

causing shortness of breath followed by high temperature or fever. It is need of an hour to prevent the spread of the virus further by following necessary steps such as

- Avoiding contact with surfaces
- Sanitizing the palms and monitoring our temperature from time to time
- Avoiding the touching of eyes, nose and ears when present in public
- Wearing face mask to avoid direct contact with people and virus from entering the mucus glands.

However, in public places there are security guard who does the job of monitoring every individual's temperature who's entering the organization. This process is not only a tedious job also put the guard in the risk of infection. The main aim of this project is to build an automatic monitoring system that checks the temperature of the individual and sanitizing the palms automatically without the need of human thereby preventing the risk of infection when people are at public places.

This system eliminates the need of a human to monitor people. After building the concept, further design and modeling is carried out. Key concepts of these projects are

- Sanitizing the palms of every individual
- Checking the temperature
- Denying entry after the decided number of people have entered.
- Maintaining Social Distance between two individuals standing in a queue .

RESULT

Temperature Detection:



The System will detect the temperature when the user touches the LM 35 temperature sensor and will display the value of the Temperature on the LCD Screen.

Entry Counting:



The number of people entering will be detected using the Entry Counter and the IR Sensor and the total entries will be displayed on LCD Screen.

Denying Entry after Limit Exceeds:



If the number of entries exceed the decided limit of entries, a message "NO ENTRY" is displayed on the LCD Screen.

Distance Detection:

1)

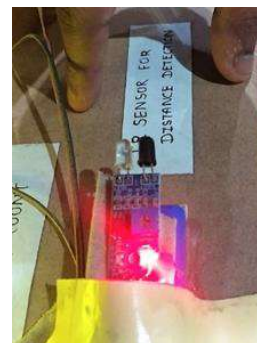

The IR Sensor will detect whether there is enough social distance between two individuals standing in a queue.

2)

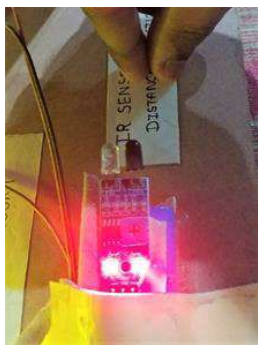

If there is not enough distance between two individuals, then the LED on the IR Sensor will be lit and the buzzer will also start ringing.

FUTURE SCOPE

As a future scope, this prototype can be used as a safety tool in many public places like Offices, Markets, Shopping Malls, Railway Stations, Colleges, Schools and Police Stations etc. Also, with some more modifications this can also help in restricting someone trying to forcefully open the door and help in the security of several public places.

CONCLUSION

According to the results and discussion, the system can function smoothly with low detection error when testing hand sanitizers automatically. If the system is working properly, Covid-19 can be avoided. Many persons will be unlikely to come into contact with the pumping handle if the proposed technique is implemented, reducing the transmission of the fomite virus and making hand sanitizer use far more convenient. In addition, the system consistently dispenses a regular quantity of hand sanitizer, allowing refilling and replacements to be simple. A temperature sensor is also used to track the subject's body temperature. Utilizing IOT technology, this proposed system might detect people who have COVID 19.

As a result of the reduced waste emissions, this is simultaneously cost-effective and environmentally benign. The automated hand sanitizer gadget used in this study is intended to help with contactless hands

disinfection in public situations and long-term viral infection prevention.

REFERENCES

1. Goda Vasantharao et al., "Temperature Detection and Automatic Sanitization and Disinfection Tunnel- COVID 19", The International journal of analytical and experimental modal analysis, June/2020.
2. Swapnil Kumbhar et al., "Thermal Controlled Contactless Smart Door System and Touchless Sanitizer", International Journal of Engineering Research & Technology (IJERT), Vol. 10 Issue 05, May-2021
3. Santosh Panchal et al., "Automatic Opening and Closing of Door" International Journal of Applied and Pure Science and Agriculture (JAPSA) Volume 02, Issue 05, [May-2016].
4. Dr. Deo Raj Tiwari et al., "Automatic Garage Door Opener", Global Journal for Research Analysis Volume-7, Issue-2, February-2018.
5. Baina Kiran et al., "Motion Based Automatic Garage Door Opener" International Journal of Engineering Trends and Applications (IJETA) Volume 5 Issue 2, Mar-Apr 2018.
6. Abhinandan Sarkar et al "Design of Automatic Hand Sanitizer with Temperature Sensing", International Journal of Innovative Science and Research Technology, Volume 5, Issue 5, May – 2020.
7. Rajat Vyawahare et al., "Automatic Door Knob/Handle Sanitization using UV-C Light", International Research Journal of Engineering and Technology (IRJET), Volume: 07 Issue: 07 | July 2020.
8. Akshay Sharma et al "Review on Automatic Sanitizer Dispensing Machine", International Journal of Engineering Research & Technology (IJERT), Vol. 9 Issue 07, July-2020.
9. D.S. Yawas et al, "Development of an Automatic Door System" American Journal of Engineering Research (AJER), Volume-7, Issue-5, pp-168-173.
10. Rinah Kim et al "Development of the Noncontact Temperature Sensor Using the Infrared Optical Fiber Coated with Antifog Solution", Hindawi Publishing Corporation Science and Technology of Nuclear Installations Volume 2015.
11. Leo Louis et al, "Working Principle of Arduino and using it as a Tool for Study and Research", International Journal of Control, Automation,

Communication and Systems (IJACS), Vol.1, No.2, April 2016.

12. Jessica Hillburn et al , "Use of alcohol hand sanitizer as an infection control strategy in acute care facility", American Journal of infection control Volume 31, Issue 2, April 2003.

13. Kim, S.I. et al "Walk-Through screening center for COVID-19" an accessible and efficient screening system in a pandemic situation." Journal of Korean Medical Science, 35(15).

14. Charles Ndujiuba et al , "Design and Implementation of a Microprocessor based Temperature Controller with Real Time Display", International Conference Comp., Energy, Net. , Robotics and Telecom, pp.14-18, 2012.

15. Jarande Pramila.M et al "Wireless Temperature detector System using ARDUINO and IOT" , International Journal of Computer Trends and Technology (IJCTT) –Volume 67 Issue 11 - November 2019.