

# APPLICATION OF COVID-19 MPPT ALGORITHM TO SOLAR ENERGY CONVERSION SYSTEM

Dr.P.Venkatesan<sup>1</sup>, M.Gowsalya<sup>2</sup>, C.Yasodha<sup>3</sup>

<sup>1,2,3</sup>Mahendra Institute of Technology

**Abstract:** Solar PV energy conversion system and wind energy conversion system are the alternate sources of energy to the conventional sources such as coal and fossil fuels. By operating the converters, maximum power can be received from the solar and wind energy conversion system. Many Maximum Power Point Tracking (MPPT) controlling techniques are available for solar and wind energy conversion system. This paper proposes two MPPT controlling techniques namely Covid-19 MPPT and FLC based MPPT for solar PV energy conversion system. MATLAB is used to implement the two proposed MPPT techniques. The first proposed Covid-19 method combines the features of incremental conductance and hill climbing methods. The incremental conductance method, calculate the perturbation direction for operating the PV modules. The hill climbing method is simple and less parameters are involved. In incremental conductance method Maximum Power Point (MPP) is reached when  $dI/dV$  is equal to the incremental conductance. In hill climbing method the MPP is reached based on the comparison of power in the present and previous instances. In the proposed Covid-19 MPPT controlling technique both incremental conductance and change of power are considered to reach the MPP. This hybrid technique produces maximum output power form solar PV for the different temperature and irradiation levels. Hence the proposed Covid-19 method proceeds in the right direction and quickly reaches the MPP.

**Keywords:** Covid-19 MPPT algorithm, Maximum power point tracking (MPPT), Fuzzy Logic Controller (FLC), single-ended primary-inductor converter (SEPIC), PV array.

## 1. INTRODUCTION

The energy requirement of the world is ever increasing. Since the use of energy has become an integral part of life, its supply should be secure and sustainable. The development of any country depends on per capita annual energy consumption. Per capita energy consumption or individual increases every year. The increasing energy demands put a lot of pressure on the conventional energy sources (oil, gas and coal). But the fossil fuel based energy sources are limited in quantity and also cause environmental pollution. Therefore, there is a need for alternative energy sources which can provide us energy in a sustainable manner [2].

Cost of electrical energy is increasing day by day. This has created the researchers to work in alternate sources of energy [3]. Wind and solar are alternate sources of energy available abundantly. The power production from solar and wind is increasing every year.

Solar power is a clean form of energy. It will not emit any greenhouse gases. Many types of Maximum Power Point Tracking (MPPT) methods are available. They differ from complexity, efficiency and implementation cost. PV systems are available in standalone or grid connected system [4]. The operating point of the PV system depends on the load conditions. The PV output power changes with respect to temperature and irradiance.

### 1.2 SOLAR PV SYSTEM

The eventual application of PV modules is to use them in a system which can supply electrical energy to a set of loads. In most cases, system components, other than the PV modules, like batteries, charge controllers, inverters, etc. (also referred as balance of system or BOS) are required to achieve/realize a reliable source of power. A PV system configuration can be very simple, consisting of only a PV module and the load. At the same time, a PV system can be highly complex, comprising all possible BOS components as well as other sources of energy [2].

The PV systems are designed to supply power to electrical loads. The loads may be of DC or AC type depending upon the application, the load may require power during the daytime only or during the night-time only or even for 24h a day [2]. The load can be a DC or an AC load. Since a PV panel generates power only during sunshine hours, some energy storage arrangement is required to power the load during the non-sunshine hours. This energy storage is usually accomplished through batteries. PV system can be broadly divided into Stand-alone PV systems, Grid-connected PV systems and Hybrid PV system.

### 1.2.1 Modeling of Solar Cell

The single diode equivalent of solar PV cell is shown in Figure 1. The output of the solar PV cell depends on the radiation and temperature. Present values of temperature and radiation are considered to get the value of maximum power point. The manufacturer will provide  $I_{SC}$  and  $V_{OC}$  of their PV panels. The mathematical model is derived based on these values [4]. Single solar will not be sufficient for a particular solar application. Solar PV panels can be connected in series to get the required voltage and connected in parallel to get the desired load current.

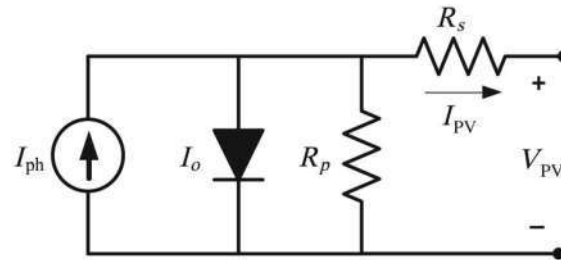

Figure 1. Equivalent circuit of solar PV cell

Therefore, to enhance the performance all cells in the PV module ( $N_s$  being the given number) contribute to the output power. The module output current can be obtained by using the following equation [3].

$$I_{PV} = I_{ph} - I_{01} e^{\left(\frac{q(V_{PV} + I_{PV}R_s)}{N_s A K T_k}\right) - 1} - \frac{(V_{PV} + I_{PV}R_s N_s)}{R_p N_s} = 0 \quad (1)$$

where  $I_{PV}$  and  $V_{PV}$  refer to the output current and output voltage, respectively.  $I_{PV}$  and  $V_{PV}$  will be added through the load or network grid [4].  $I_{01}$  refers to the diode saturation,  $A$  stands for the diode ideality factor,  $q$  is the electron charge constant ( $q = 1.602 \times 10^{-19}$  C),  $K$  represents the Boltzmann constant,  $T_k$  is the operating temperature that is equal to the reference temperature (25°C), and  $I_{ph}$  represents the solar-generated current. In equation 1.1, the parallel resistance ( $R_p$ ) generally has a high value and sometimes assumes infinity in PV module modeling because of its slight impression. By contrast, the value of series resistance ( $R_s$ ) cannot be neglected because of its effect on output power [4].

The electrical efficiency of the PV module is given by

$$\eta_0 = \frac{\gamma V_{MPP}}{\beta} \quad (2)$$

where

- $\gamma$  = temperature coefficient of maximum power point efficiency
- $\beta$  = the voltage temperature coefficient

$V_{MPP}$  = Voltage at maximum power point at standard test conditions.

A stand-alone system is the one which is not connected to power grid. In contrast, the PV systems connected to the grid are called grid-connected PV system. Hybrid PV systems could be stand –alone or grid-connected type, but have at least one more source other than the PV [2]. A hybrid system with PV as the main source is called a hybrid PV system.

## 2. Previous Research

Yuxiang Shi et al. (2016) proposed a low frequency ripple free MPPT algorithm for grid tied PV system. The solar PV system is connected to the load through a current fed dual active bridge converter with multilevel inverter. In this configuration the small film capacitor replaces the high capacitor normally present in the system. This arrangement offers high efficiency even at rapidly varying environmental conditions. A 5kW PV converter was developed to test the performance of this algorithm. Controlling of the dual active bridge and multilevel inverter is the disadvantages of this method.

Markus Andresen et al. (2016) proposed a MPPT controlling techniques for solar PV system. This technique takes into the account of thermal stress of semiconductor switches in the converter. Therefore the losses are reduced and the overall efficiency improved. This algorithm worked better for the rapidly changing irradiance environmental conditions.

Bader et al. (2013) developed Fuzzy Logic Control (FLC) for MPP in solar PV system. In this algorithm the change of power and change of current were considered as input variables and change of duty cycle was considered as output variable. The input variables are divided into four fuzzy levels such as Positive Big, Positive small, Negative Small and Negative Big. The output variable was divided into six fuzzy levels such as Positive Big, Positive Medium, Positive Small, Negative Small, Negative Medium and Negative Big. The rule base are derived relating the input and output variable (Bader et al. 2013). If fuzzy level increases the accuracy increases and the MPP will be reached quickly.

Chun Wei et al. (2016) developed an MPPT algorithm for wind energy conversion system. A combination of artificial neural network and Q learning algorithm is used to obtain maximum power point. The maximum power is tracked for the corresponding rotor speed. Simulation and experimental results are provided to validate the proposed ANN-based MPPT control algorithm for a 5-MW permanent magnet synchronous generator based wind energy conversion system (WECS) and a small emulated PMSG-based WECS, respectively (Chun Wei et al. 2016). The ANN requires more time for training.

Jakeer&Mahesh (2016) present an adaptive maximum power point tracking algorithm for small-scale wind energy conversion systems to harvest more energy from turbulent wind. The proposed algorithm combines the computational behavior of hill climb search, tip speed ratio, and power signal feedback control algorithms for its adaptability over wide range of WECSs and fast tracking of maximum power point. This MPPT algorithm is implemented by using buck–boost featured single-ended primary inductor converter to extract maximum power from full range of wind velocity profile. Evaluation of the proposed algorithm is done on a laboratory-scaled dc motor drive-based WECS emulator. The control scheme is implemented by the 32 bit digital computer. Experimental results show that tracking capability of the this algorithm under sudden and gradual fluctuating wind conditions is efficient and effective (Jakeer&Mahesh 2016).

Yipeng&Heng (2015) presented a modularized control strategy for wind energy conversion system. Two converters such as grid side and rotor side converters are considered and both the converters are operated to reach MPP. The unbalanced harmonic grid voltage. This method is implemented under unbalanced and distorted grid voltage. The advantage of this method is the elimination of negative harmonics.

YinruBai et al. (2015) designed a wind turbine generator system for outdoor generation. In Normal wind energy conversion system buck/boost converter will be used obtain the maximum power point. But in this structure there is no power electronic converter is required. It is highly reliable of outdoor use. A prototype of this structure is developed and tested. The simulation results are confirmed by the experimental results. The disadvantage of this scheme is the design of this special generator.

### **3. Covid-19 method for MPPT in Solar PV Energy Conversion system**

Conventional power generation from coal is going to be exhausted in approximately 200 years. The power generation from oil and gas is very minimum. Power generation from non-conventional energy resources is to be promoted to meet the power demand of future. In renewable energy resources, Wind and solar are the major energy resources.

The availability of solar power is tremendous. The fossil fuels such as coal, oil and gasses are going to be exhausted in the next 200 years approximately. Solar power is an alternate source of renewable energy. The solar power is going to rule over the world in the years to come. Many techniques are developed day by day to improve the efficiency of solar power conversion. Maximum Power Point Tracking is one of the well-known method to improve the efficiency of solar power energy conversion system. In maximum power point tracking the current and voltage of the solar panel is tracked for the corresponding temperature and solar irradiation. Whatever the variation in temperature and solar irradiation, but the output power is maintained to have maximum value.

A solar cell performs three functions. First the solar cell absorbs light. Second it will separate the charge carriers generated in it. Thirdly transport the separate the charge carriers to external load without resistive loss. A PV installation requires several components other than PV panels. These components are battery charge controllers, DC-DC converters, DC-AC converters for AC loads and grid connected systems supporting structures for mounting the PV panels, protection relays and so on. DC-DC converters are used for converting DC voltage to regulated DC voltage with the help of several components. They are power storage devices such as capacitors and inductors and power devices like transistors and diodes. The DC-DC converter is controlled by MPPT controller. Basically the MPPT controller will receive PV voltage and current as input and process the input signals and produce the output signal which controls the power devices like SCR, MOSFET or IGBT with passive components like diodes. The MPPT controller will implement the MPPT procedure with the help of digital controller. The DC voltage output can be directly supplied to load or to the DC-AC converter to invert to AC for supplying ac loads.

Solar PV voltage and current are the two important parameters for the MPPT algorithm. These two quantities are measured from the PV panel and send to the MPPT controller. The MPPT controller will process the solar PV voltage and

current and process and generate control signals. These control signals are combined with PWM generator to produce the gate signals for the boost converter. The output of the boost converter is connected to the filter before it is connected to the load. The block diagram of the PV control system is shown in Figure 2.

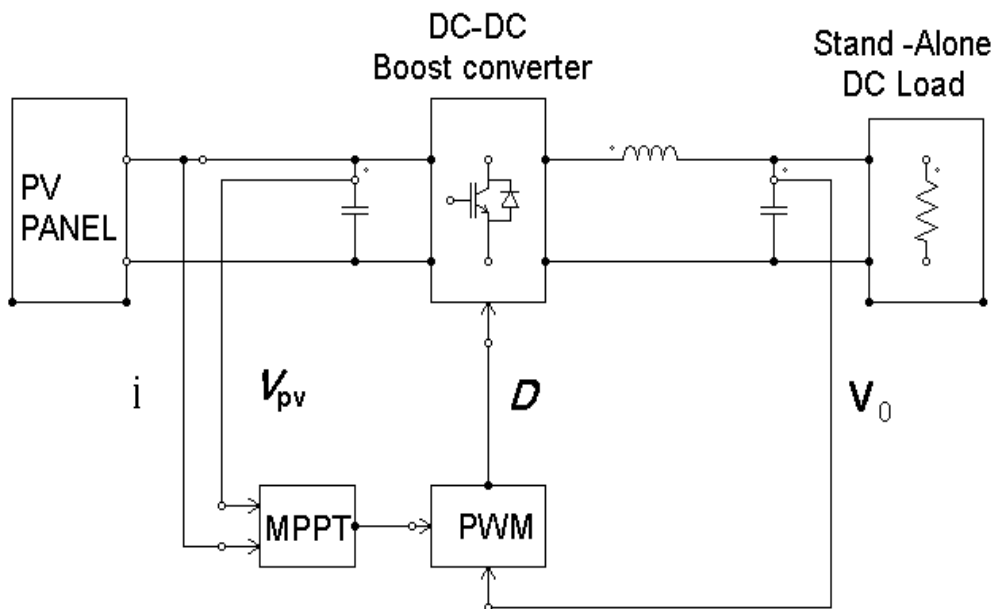

Figure 2. PV System and control diagram

### 3.1. Covid-19 Algorithm based MPPT

The proposed Maximum Power Point Tracking algorithm for solar PV energy conversion system is a hybrid of Incremental Conductance and Hill climbing algorithms. In incremental conductance method, from the measurement of solar PV voltage and current the incremental conductance and static conductance are calculated and then voltage correction is carried out. In Hill Climbing method, from the measurement of solar PV voltage and current the solar PV power is calculated for the two successive interval of time and based on the increment or decrement of power the duty cycle is adjusted to reach the Maximum power point. In the proposed Covid-19 MPPT algorithm, first the change in power from the values of voltage and current measurement is calculated and then the values of the incremental conductance and static conductance are calculated. Based on these values the duty cycles are corrected to reach the Maximum power point. Figure 3 shows the in the flow chart of the proposed MPPT algorithm.

Initially, the control action is taken based on the power calculation in the two consecutive intervals. The second stage control action is taken based on the incremental conductance and change in current. At the end either increment the duty cycle or decrement the duty cycle is carried out. The voltage and current values are updated and the cycle continuous to track the maximum power point.

The solar panel current and voltage are given as input to the MPPT algorithm. In MPPT algorithm, present value of a quantity is represented by a letter with (n) and the previous value of the quantity is represented by a letter with (n-1).

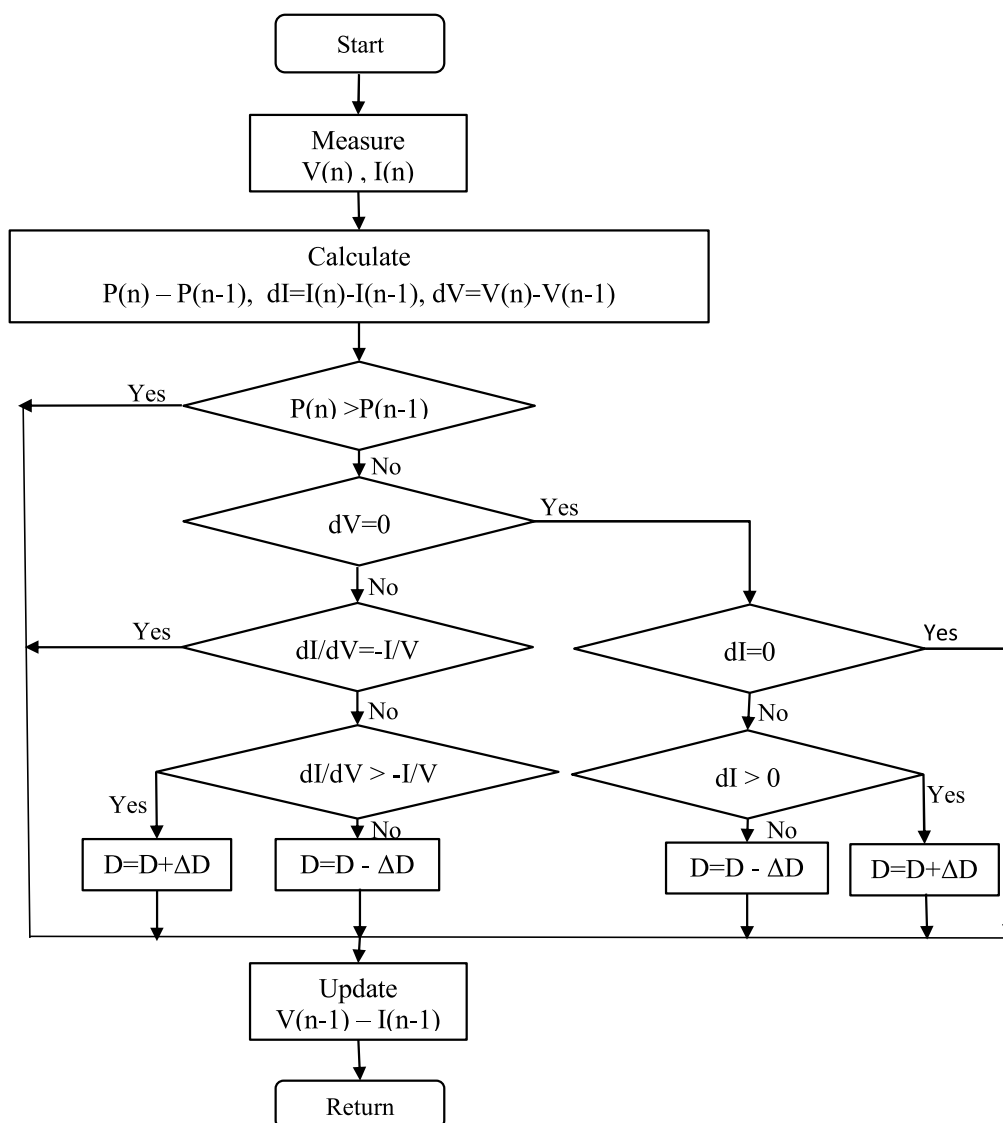

**Figure 3. Flow diagram of Covid-19 method for MPPT of solar power**

The This algorithm has four cases as given below

**Case 1:** If Power  $P(n) > P(n-1)$ , then update voltage  $V(n-1)$  and current  $I(n-1)$

**Case 2:** If Power  $P(n) < P(n-1)$  &  $dV = dI = 0$ , then update voltage  $V(n-1)$  and current  $I(n-1)$ .

If Power  $P(n) < P(n-1)$  &  $dV \neq 0$  &  $dI/dV = -I/V$ , then update voltage  $V(n-1)$  and current  $I(n-1)$ .

**Case 3:** If Power  $P(n) < P(n-1)$  &  $dV \neq 0$ , then

If  $dI/dV > -I/V$  then duty cycle  $D=D+\Delta D$  and update voltage  $V(n-1)$  and current  $I(n-1)$ .

If  $dI/dV < -I/V$  then duty cycle  $D=D-\Delta D$  and update voltage  $V(n-1)$  and current  $I(n-1)$ .

**Case 4:** If Power  $P(n) < P(n-1)$  &  $dV=0$  &  $dI \neq 0$ , then

If  $dI > 0$ , duty cycle  $D=D-\Delta D$  and update voltage  $V(n-1)$  and current  $I(n-1)$ .

If  $dI < 0$ , duty cycle  $D=D+\Delta D$  and update voltage  $V(n-1)$  and current  $I(n-1)$ .

In this hybrid MPPT algorithm for solar power system, from the measurement of solar panel output voltage and current the solar power is calculated. The duty cycle is adjusted by a small amount  $\Delta D$  to reach the maximum power point based on the change of solar power,

voltage and current. This algorithm is very effective, since it considers all the three parameters of the solar PV system such as voltage current and power.

### 3.2. Fuzzy logic controller based MPPT

The limitation of the PI controller that is useful only for linear systems. The SEPIC converter is linearized at a certain operating condition and a particular PI controller is designed for it. But to improve the SEPIC for multi variable operating conditions, fuzzy logic controller can be used. The advantage of fuzzy logic controller is that its ability to deal with nonlinearities and uncertainties. It is robust and adaptive control. This is a very important issue of two fold, on one hand, research part which deals with the improvement of controller design of multivariable, nonlinear, unstable, time delay with uncertainties systems and on the other hand, industrial applications where the main objective is to obtain practical solutions with low cost of their problems nonlinear systems. Fuzzy logic provides a method to make definite decisions based on imprecise and ambiguous input data. Fuzzy logic is widely used for applications in control systems, since it closely resembles how a human make a decision but in a faster way. Fuzzy logic can be incorporated in control systems based on small handheld devices to large PC workstations. Fuzzy logic allows making a definite decision based on imprecise or ambiguous data, whereas ANN tries to incorporate human thinking process to solve problems without mathematically modeling them. Even though both of these methods can be used to solve nonlinear problems, and problems that are not properly specified, they are not related.

There are various techniques used for tracking maximum power like Perturb and Observe (P&O), Incremental Conductance (IC) and Fuzzy Logic Control (FLC). Among these algorithms, FLC is equipped in this work. FLC has the advantage of an easy implementation. It does not need any accurate mathematical model of the system and it is very suitable for nonlinear system. It works under intelligent control method. In FLC, the given crisp set values are converted into linguistic variables by using fuzzification unit. The reference value is decided and according to the actual value of the voltage and power, the error value is calculated. By using this error value the change in error value is calculated. The two FLC input variables are the error E and change of error CE at sampled time k as shown in equations (3) and (4).

$$E(k) = \frac{P(k) - P(k-1)}{V(k) - V(k-1)} \quad (3)$$

$$CE(k) = E(k) - E(k-1) \quad (4)$$

where P(k) is the output power of the PV generator at the kth sampling instant. The input E(k) indicates whether the operating point at the instant k is located on the left or right of the maximum power point on the PV Characteristics. while the input CE (k) expresses the moving direction of this point. The fuzzy inference is carried out by using Mamdani's method and the defuzzification uses the centre of gravity to compute the output of the FLC which is the duty cycle d of the SEPIC.

The control rules are indicated in Table 1. with E and CE as inputs and d $\alpha$  as the output. The rule evaluation uses the fuzzified output from the fuzzification stage and the rule base to produce the fuzzy output variable. The defuzzification stage converts the fuzzy output variable that is produced from the rule evaluation into a single real number. In the rule, NB stands for negative big, NS is negative small, ZE is zero, PS is positive small and PB is positive big.

**Table 1. Fuzzy Rule Table**

$CE/E$	NB	NS	ZE	PS	PB
NB	ZE	NS	NS	NB	NB
NS	PS	ZE	NS	NS	NB
ZE	PS	PS	ZE	NS	NS
PS	PB	PS	PS	ZE	NS
PB	PB	PB	PS	PS	ZE

The membership functions for error (E) change of error (CE) and output for shown Figure 3.

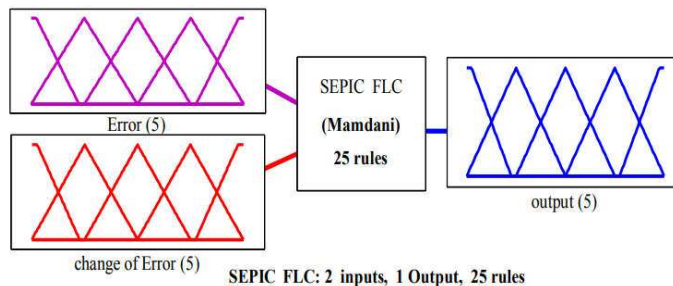
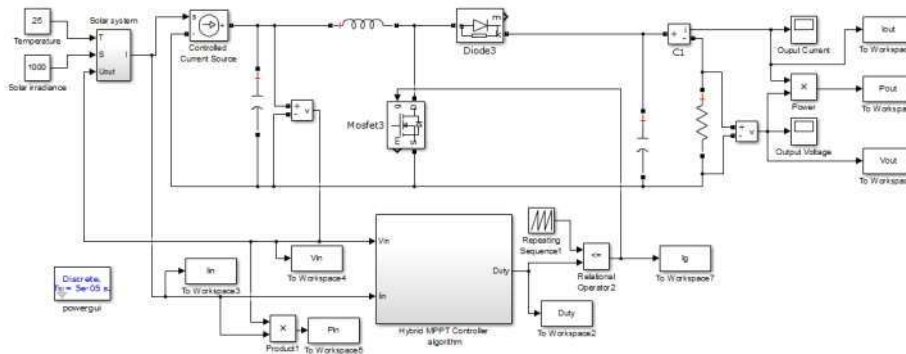

**Figure 3. Membership function for MPP**

### 4. Simulation Results and Discussion

The The MPPT algorithm for solar power system is implemented in MATLAB as a sub-system. Solar panel is simulated in MATLAB. Temperature and irradiance are taken as input to the solar panel. The solar panel develops voltage across its output terminals according to the temperature and irradiance. The solar panel is connected to the boost converter. The converter matches the impedance of the solar panel to the impedance of the load to enable to transfer the maximum power from solar PV system to the load. The boost converter feeds the load. When the load changes, the solar panel acts as a source supplying the power. MPPT for the solar panel is achieved by hybrid the incremental conductance and hill climbing methods.

The simulation model of MPPT based solar power system in MATLAB is shown in Figure 4 below.





#### Figure 4 Simulation model of Hybrid MPPT for solar power system

The boost converter switch is controlled by hybrid MPPT controlling technique. The duty cycle is developed by the MPPT controller is combined with repeating sequence signal to make suitable Pulse Width Modulation (PWM) control signal for the boost converter. The output current of the solar panel is smoothed by the inductor connected in series with the solar panel. Boost converter output voltage is smoothed by the capacitor connected at the output of the boost converter. The solar panel output current, voltage and power and load voltage, current and power are measured and displayed.

Three different solar irradiance are considered to analyse the performance of the proposed hybrid of incremental conductance and hill climbing algorithm for maximum power point tracking. Three different temperatures are taken into consideration to test the effectiveness of the proposed algorithm. The output current, output voltage and output power are obtained with and without MPPT control. The output current, output voltage and output power are obtained and displayed.

The proposed hybrid of Incremental Conductance and hill climbing control algorithm for maximum power point tracking in solar PV system is tested for the solar irradiance of  $500\text{W/m}^2$  and temperature of  $23^\circ\text{C}$ . The solar PV output voltage, output current and output power are plotted with respect to time. Figure 5, Figure 6 and Figure 7 show the solar PV output voltage, current and power respectively.

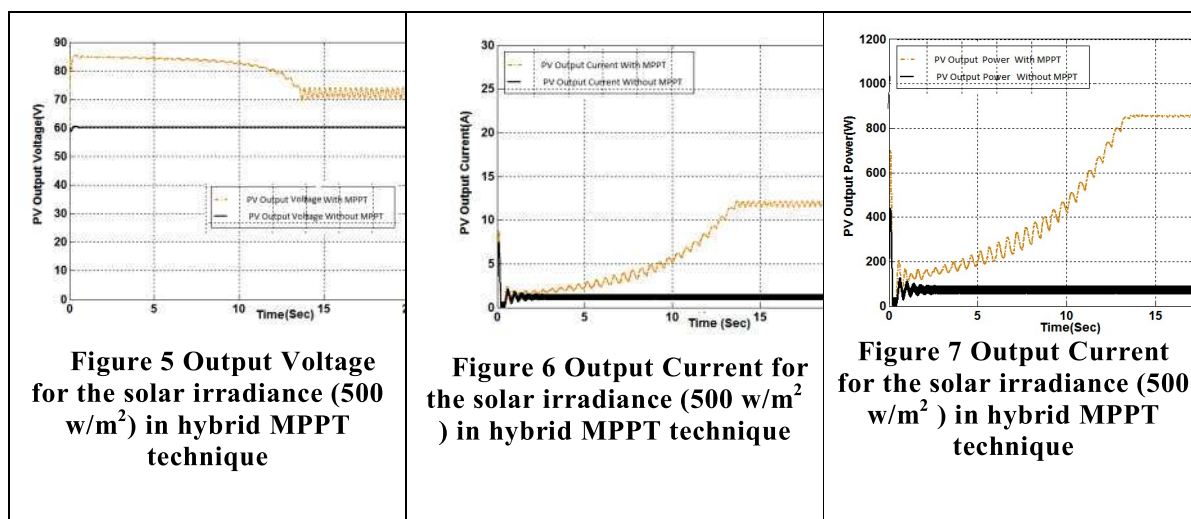

**Figure 5 Output Voltage for the solar irradiance ( $500\text{w/m}^2$ ) in hybrid MPPT technique**

**Figure 6 Output Current for the solar irradiance ( $500\text{w/m}^2$ ) in hybrid MPPT technique**

**Figure 7 Output Power for the solar irradiance ( $500\text{w/m}^2$ ) in hybrid MPPT technique**

The solar PV output voltage and current reached the steady value in 13 seconds. The solar PV output power is also reached the maximum value in 13 seconds. The steady value of solar PV output voltage of 72V and output current of 11.66A are obtained. The maximum solar PV output power received is 840W for the solar irradiance of  $500\text{W/m}^2$  and temperature of  $23^\circ\text{C}$ . Without MPPT the solar PV output power received is only 90W for the same irradiance and temperature.

The proposed hybrid of Incremental Conductance and hill climbing control algorithm for maximum power point tracking in solar PV system is tested for the solar irradiance of  $600\text{W/m}^2$  and temperature of  $25^\circ\text{C}$ . The solar PV output voltage,

output current and output power are plotted with respect to time. Figure 8, Figure 9 and Figure 10 show the solar PV output voltage, current and power respectively.

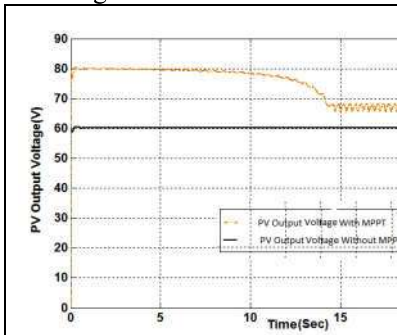

**Figure 8 Output Voltage for the solar irradiance (600 w/m<sup>2</sup>) in hybrid MPPT technique**

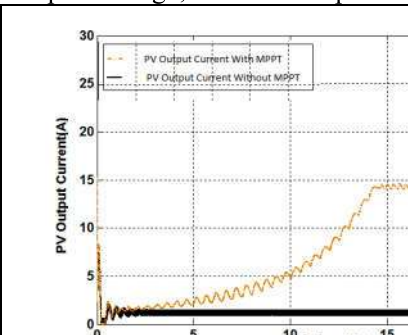

**Figure 9 Output Current for the solar irradiance (600 w/m<sup>2</sup>) in hybrid MPPT technique**

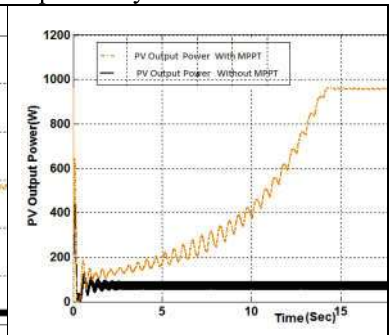

**Figure 10 Output Power for the solar irradiance (600 w/m<sup>2</sup>) in hybrid MPPT technique**

The solar PV output voltage and current reached the steady value in 14 seconds. The solar PV output power is also reached the maximum value in 14 seconds. The steady value of solar PV output voltage of 68V and output current of 13.97A are obtained. The maximum solar PV output power received is 950W for the solar irradiance of 600 W/m<sup>2</sup> and temperature of 25<sup>0</sup>C. Without MPPT the solar PV output power received is only 90W for the same irradiance and temperature.

The proposed hybrid of Incremental Conductance and hill climbing control algorithm for maximum power point tracking in solar PV system is tested for the solar irradiance of 1000W/m<sup>2</sup> and temperature of 30<sup>0</sup>C. The solar PV output voltage, output current and output power are plotted with respect to time. Figure 11, Figure 12 and Figure 13 show the solar PV output voltage, current and power respectively.

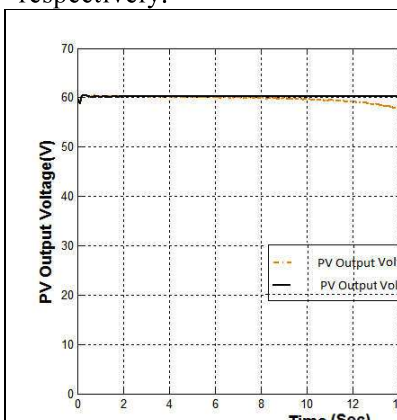

**Figure 11 Output Voltage for the solar irradiance (1000 w/m<sup>2</sup>) in hybrid MPPT technique**

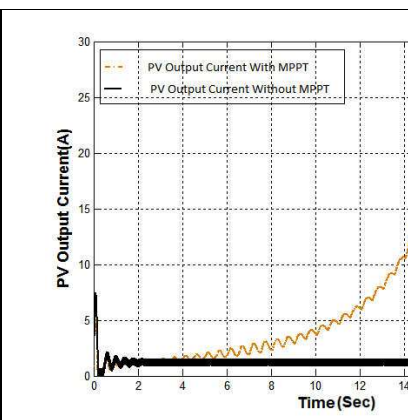

**Figure 12 Output Current for the solar irradiance (1000 w/m<sup>2</sup>) in hybrid MPPT technique**

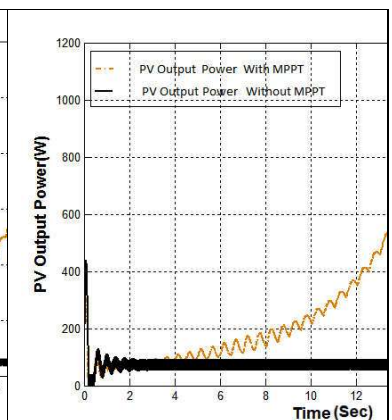
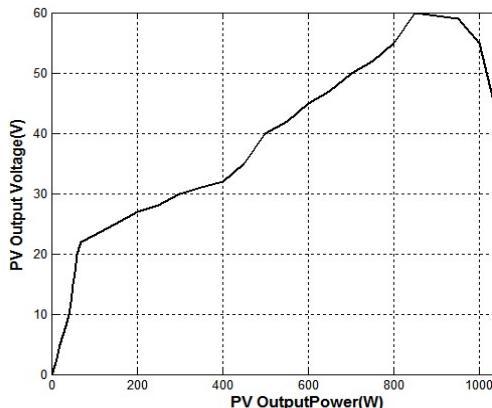

**Figure 13 Output Power for the solar irradiance (1000 w/m<sup>2</sup>) in hybrid MPPT technique**

The solar PV output voltage and current reached the steady value in 16.5 seconds. The solar PV output power is also reached the maximum value in 16.5 seconds. The

steady value of solar PV output voltage of 68V and output current of 22.4A are obtained. The maximum solar PV output power received is 1120W for the solar irradiance of 1000 W/m<sup>2</sup> and temperature of 30°C. Without MPPT the solar PV output power received is only 90W for the same irradiance and temperature.

The output voltage versus output power for the solar irradiance of 1000W/m<sup>2</sup> in hybrid MPPT technique is shown in Figure 14



**Figure 14 Voltage versus Power for the solar irradiance (1000 w/m<sup>2</sup>) in hybrid MPPT technique**

The maximum voltage developed in the solar PV panel is 60 Volts, but the maximum power developed in solar PV panel is 1120Watts at nearly 50Volts.

The Voltage versus Current for the solar irradiance (1000 w/m<sup>2</sup>) in hybrid MPPT technique is shown in Figure 15. The maximum voltage developed in the solar PV panel is 60 Volts and the maximum current developed in the solar PV panel is 25 Amps. The maximum power is developed solar PV panel is 1120 Watts at 50Volts and 22.4 Amps.

**Table .1 : Performance of solar PV system for Covid-19 MPPT**

Solar Irradiation (W/m <sup>2</sup> )	Voltage (V)	Current (A)	Power (W)
500	72	11.66	840
600	68	13.97	950
1000	50	22.40	1120

**Table 2: Performance of solar PV system for FLC**

Solar Irradiation(W/m <sup>2</sup> )	Voltage (V)	Current (A)	Power (W)
500	34.1	18.2	620
600	35.4	22.5	760
1000	42.2	25.1	1050

When the solar irradiance increases the solar PV output power is also increases. The solar PV voltage and current are gradually changing when there is a change in solar irradiation. The proposed FLC based MPPT controlling technique reaches the maximum power point within 5 seconds.

#### 4. Conclusion

Covid-19 MPPT algorithm is one the proposed controlling technique for the solar system. In Covid-19 MPPT algorithm the incremental conductance and hill climbing methods are combined to get the advantages of both the methods. In incremental conductance method the present incremental conductance of the solar system is considered and control action is taken. In Covid-19 MPPT algorithm the incremental conductance and power of the solar system are considered for taking control action. Based on the incremental conductance and power of the solar system in the two consecutive interval of time are taken to adjust the duty cycle of the boost converter. The proposed Covid-19 MPPT algorithm is simulated in MATLAB. It is found that for any increment in solar irradiation the solar power also increases. A maximum of 1120Watts are generated for the solar irradiance of  $1000\text{w/m}^2$ . For any change in solar irradiation the MPP is reached in 13 to 17 seconds. In the two proposed MPPT techniques for the solar power system, the Covid-19 MPPT is considered the best since it controls the boost converter to get maximum power for any value of solar irradiation compared to FLC based MPPT technique.

#### REFERENCES

- [1] A. Andrea Montecucco & Andrew R Knox 2015, 'Maximum Power Point Tracking converter based on the open circuit voltage method for thermoelectric generators', *IEEE Transactions on Power Electronics*, vol.30, no.2, pp. 828-839.
- [2] Chetan Sing Solanki 2011, *Solar Photovoltaics Fundamentals Technologies and Applications*, Prentice-Hall, New Delhi.
- [3] A. El Khateb, N. A. Rahim, and J. Selvaraj, "Optimized PID controller for both single phase inverter and MPPT SEPIC DC/DC converter of PV module," in *Proc. IEEE IEMDC*, May 15–18, 2011, pp. 1036–1041.
- [4] Bidyadhar Sududhi & Raseswari Pradhan 2013, 'A comparative study on maximum power point techniques for photovoltaic systems', *IEEE Transactions on Sustainable Energy*, vol. 4, no. 1, pp. 89-98.
- [5] P. Venkatesan, S. Kannan, "Application of Fuzzy Logic Controller to Solar Energy Conversion System with SEPIC Converter", *Compliance Engineering Journal* (0898-3577)/ Volume 11 Issue 2. (Feb 2020). (UGC Approved)
- [6] P. Venkatesan, C. Yasodha, D. Arul, "Energy Conversion for Combined Wind and PV System using Hybrid Excellence Controller", *Journal of Applied Science and Computations* (1076-5131)/ Volume VI, Issue III, March/2019.
- [7] P. Venkatesan, A. Subramani, "Implementation of SEPIC Converter in a Off-Grid PV System using advanced MPPT Techniques", *Journal of Applied Science and Computations* (3483-3489)/ Volume VI, Issue VI, June/2019.

- [8] Venkatesan.P, Senthilkumar.S, “Design of Hybrid Boost Converter for Hybrid Renewable Applications”, *Asian Journal of Research in Social Sciences and Humanities Vol. 6, Special conference Issue Sept 2016*, pp. 33-45. ISSN 2249-7315.
- [9] Venkatesan.P, Senthilkumar.S, “Design of Multiport Hybrid Boost Converter based ANFIS Controller (MHBC-ANFIS) for Hybrid renewable Applications”, *Transylvanian Review : Vol XXIV issue 2016; No.10*. ISSN: 1221-1249.
- [10] Venkatesan.P, Senthilkumar.S. “ Design and Implementation of Photovoltaic System Using Hill Climbing MPPT Algorithm”, *International Journal of Applied Engineering Research*, ISSN 0973-4562 Volume 9, Number 23 (2014) pp. 19915-19924.
- [11] Venkatesan.P, Senthilkumar.S, “Design and Implementation Wind Power Using Hill Climbing Mppt Algorithm”, *Middle-East Journal of Scientific Research* 24 (1): 80-87, 2016, ISSN 1990-9233.
- [12] Venkatesan.P, Senthilkumar.S, “Wind and Solar Energy Conversion Using Power Electronics System”, *International Journal of Advanced and Innovative Research* (2278-7844) / # 124 / Volume 3 Conference Issue.
- [13] Venkatesan.P, Senthilkumar.S, “Battery Charger for Wind and Solar Energy Conversion System Using Buck Converter”, *International Electrical Engineering Journal (IEEJ)*, ISSN 2078-2365, Vol. 5 (2014) No. 1, pp. 1198-1203
- [14] Venkatesan.P, Senthilkumar.S, “Wind and Solar Energy Conversion System Using MPPT Based Power Electronics”, *International Journal of Engineering (IJE) Singaporean Journal of Scientific Research(SJSR)*, Vol.6.No.5.2014 Pp.235-240.
- [15] Venkatesan.P, Senthilkumar.S, “Fuzzy logic Control based IUPQC for Power Quality Improvement on Distribution Network” *Journal of Computing Technologies* (ISSN: 2278 – 3814) / # 74 / Volume 4 issue 10 (October - 2015).
- [16] Venkatesan.P, Senthilkumar.S, “Adaptive Voltage Control for Renewable Energy Integrated With Smart Grid” *Journal of Computing Technologies* (ISSN: 2278 – 3814) / # 74 / Volume 4 issue 10 (October - 2015).
- [17] Venkatesan.P, Senthilkumar.S, “Neuro-Fuzzy Logic Controller for Wind Energy Conversion System” *Journal of Computing Technologies* (ISSN: 2278 – 3814) / # 74 / Volume 4 issue 10 (October - 2015).
- [18] Venkatesan.P, Senthilkumar.S, “Design and Implementation of SEPIC converter for Solar Energy Conversion System Using Hill Climbing MPPT Algorithm” *Journal of Computing Technologies* (ISSN: 2278 – 3814) / # 54/ Volume 5 issue 4 (April - 2016).
- [19] Venkatesan.P, Senthilkumar.S, “Solar Energy Conversion System using Ripple free MPPT for Grid connected PV system” *Journal of Computing Technologies* (ISSN: 2278 – 3814) / # 68/ Volume 5 issue 4 (April - 2016).
- [20] Venkatesan.P, Ahalya.M, “Design of MPSS and TCSC Damping Controllers in Multi- Machine Power System Using BFO”, *International Journal of Modern Trends in Engineering and Research (IJMTER)*, e-ISSN: 2349-9745, p-ISSN: 2393-8161, Volume 02, Issue 01, [January - 2015].
- [21] Venkatesan.P, Ezhilya.V, “Battery Charger for Wind and Solar Energy Conversion System Using Buck Converter”, *International Journal of Engineering Sciences Research*, ISSN: 2230-8504; e-ISSN-2230-8512, Vol 05, Article 01331; January 2014.
- [22] P.Venkatesan, C.Yasodha, K.Madhumathi, “Modified Hybrid MPPT for Hybrid Renewable Energy Conversion System”, *International Electrical Engineering Journal (IEEJ)* Vol. 8 (Feb 2018) No.2, pp. 2498-2502 ISSN 2078-2365

- [23] *P.Venkatesan, C.Yasodha, K.Madhumathi, "Hybrid MPPT for Hybrid Energy Conversion System", International Journal of Advanced and Innovative Research (2278-7844)/ Volume 7 Issue 1. (Feb 2018).*